

FEATURES

- O-Band specific waveguides and fibers
- X-cut for high stability
- Low drive voltage
- Low insertion loss

APPLICATIONS

- Up to NRZ-50 Gb/s - PAM-4-56 Gbaud
- General purpose intensity modulation
- Test and measurement

OPTIONS

- Analog version
- 1060 nm, 850 nm band versions

RELATED EQUIPMENTS

- Choice of RF drivers
- MBC-DG Automatic Bias Controllers
- ModBox-OBand-PAM4
- ModBox-OBand-NRZ

The MX1300-LN series are lithium niobate (LiNbO₃) intensity modulators specially designed for operation in the 1310 nm wavelength band. Thanks to their O-Band optimized optical waveguides and their 1310 nm selected fibers, the MX1300-LN can be claimed genuine 1310 nm intensity modulators.

The X-cut design of these Mach-Zehnder modulator confers them an unmatched stability in a wide range of operational conditions, as well as a zero chirp performance. ixBlue proprietary waveguide design offers a low insertion loss combined with a high contrast. Thanks to their low V_{π} , the MX1300 series are ideally suited for 10-12.5 Gb/s up to 50 Gb/s and 56 Gbaud optical transmission with NRZ, RZ, DPSK, PAM-4 and are key devices for a large variety of applications.

MX1300-LN-10 Performance Highlights

Parameter	Min	Typ	Max	Unit
Operating wavelength	1270	-	1330	nm
Insertion loss	-	3.5	-	dB
Electro-optical bandwidth	-	12	-	GHz
V_{π} RF @50 kHz	-	4	-	V

Specifications given at 25 °C, 50 Ω, 1310 nm.

MX1300-LN-20 Performance Highlights

Parameter	Min	Typ	Max	Unit
Operating wavelength	1270	-	1330	nm
Insertion loss	-	3.5	-	dB
Electro-optical bandwidth	-	25	-	GHz
V_{π} RF @50 kHz	-	4	-	V

Specifications given at 25 °C, 50 Ω, 1310 nm.

MX1300-LN-40 Performance Highlights

Parameter	Min	Typ	Max	Unit
Operating wavelength	1270	-	1330	nm
Insertion loss	-	3.5	-	dB
Electro-optical bandwidth	-	30	-	GHz
V_{π} RF @50 kHz	-	4	-	V

Specifications given at 25 °C, 50 Ω, 1310 nm.

MX1300-LN-10

12 GHz Intensity modulator

Electrical Characteristics

Parameter	Symbol	Condition	Min	Typ	Max	Unit
Electro-optic bandwidth	S_{21}	RF electrodes, -3dB from 2 GHz	10	12	-	GHz
Ripple S_{21}	$\Delta S_{21\Gamma}$	RF electrodes	-	0.5	1	dB
Electrical return loss	S_{11}	RF electrodes, $f < 10$ GHz	-	-15	-10	dB
$V\pi$ RF @ 50 kHz	$V\pi RF_{50\text{ kHz}}$	RF electrodes	-	4	5	V
$V\pi$ RF @ 10 Gb/s PRBS	$V\pi RF_{10\text{ Gb/s}}$	RF electrodes	-	4.7	5.7	V
$V\pi$ DC electrodes	$V\pi DC$	DC electrodes	-	5.5	6	V
RF input impedance	Z_{in-RF}	-	-	50	-	Ω
DC input impedance	Z_{in-DC}	-	1	-	-	M Ω

50 Ω RF input

Optical Characteristics

Parameter	Symbol	Condition	Min	Typ	Max	Unit
Crystal	-	-	Lithium Niobate X-Cut Y-Prop			
Operating wavelength	λ	-	1270	1310	1330	nm
Insertion loss	IL	Without connectors	-	3.5	4.5	dB
DC extinction ratio	ER	Measured with narrow source linewidth < 200 MHz	20	22	-	dB
Optical return loss	ORL	-	-40	-45	-	dB
Chirp	α	-	-0.1	0	0.1	-

All specifications given at 25°C, 1310 nm, unless differently specified

Absolute Maximum Ratings

Stresses in excess of the absolute maximum ratings can cause permanent damage to the device. These are absolute stress ratings only. Functional operation of the device is not implied at these or any other conditions in excess of those given in the operational sections of the data sheet. Exposure to absolute maximum ratings for extended periods can adversely affect device reliability.

Parameter	Symbol	Min	Max	Unit
RF input power	EP_{in}	-	28	dBm
Bias voltage	V_{bias}	-20	+20	V
Optical input power	OP_{in}	-	20	dBm
Operating temperature	OT	0	+70	°C
Storage temperature	ST	-40	+85	°C

MX1300-LN-20

25 GHz Intensity modulator

Electrical Characteristics

Parameter	Symbol	Condition	Min	Typ	Max	Unit
Electro-optic bandwidth	S_{21}	RF electrodes, -3dB from 2 GHz	20	25	-	GHz
Ripple S_{21}	ΔS_{21}	RF electrodes	-	0.5	1	dB
Electrical return loss	S_{11}	RF electrodes, $f < 20$ GHz	-	-15	-10	dB
$V\pi$ RF @50 kHz	$V\pi_{RF_{50\text{ kHz}}}$	RF electrodes	-	4	5	V
$V\pi$ RF @20 Gb/s PRBS	$V\pi_{RF_{20\text{ Gb/s}}}$	RF electrodes	-	5.5	6	V
$V\pi$ DC electrodes	$V\pi_{DC}$	DC electrodes	-	5.5	6	V
RF input impedance	Z_{in-RF}	-	-	50	-	Ω
DC input impedance	Z_{in-DC}	-	1	-	-	M Ω

50 Ω RF input

Optical Characteristics

Parameter	Symbol	Condition	Min	Typ	Max	Unit
Crystal	-	-	Lithium Niobate X-Cut Y-Prop			
Operating wavelength	λ	-	1270	1310	1330	nm
Insertion loss	IL	Without connectors	-	3.5	4.5	dB
DC extinction ratio	ER	Measured with narrow source linewidth < 200 MHz	20	22	-	dB
Optical return loss	ORL	-	-40	-45	-	dB
Chirp	α	-	-0.1	0	0.1	-

All specifications given at 25°C, 1310 nm, unless differently specified

Absolute Maximum Ratings

Stresses in excess of the absolute maximum ratings can cause permanent damage to the device. These are absolute stress ratings only. Functional operation of the device is not implied at these or any other conditions in excess of those given in the operational sections of the data sheet. Exposure to absolute maximum ratings for extended periods can adversely affect device reliability.

Parameter	Symbol	Min	Max	Unit
RF input power	EP_{in}	-	28	dBm
Bias voltage	V_{bias}	-20	+20	V
Optical input power	OP_{in}	-	20	dBm
Operating temperature	OT	0	+70	°C
Storage temperature	ST	-40	+85	°C

MX1300-LN-40

40 GHz Intensity modulator

Electrical Characteristics

Parameter	Symbol	Condition	Min	Typ	Max	Unit
Electro-optic bandwidth	S_{21}	RF electrodes, -3dB from 2 GHz	28	30	-	GHz
Ripple S_{21}	ΔS_{21}	RF electrodes	-	0.5	1	dB
Electrical return loss	S_{11}	RF electrodes, $f < 30$ GHz	-	-15	-10	dB
$V\pi$ RF @50 kHz	$V\pi_{RF_{50kHz}}$	RF electrodes	-	4	5	V
$V\pi$ DC electrodes	$V\pi_{DC}$	DC electrodes	-	5.5	6	V
RF input impedance	Z_{in-RF}	-	-	50	-	Ω
DC input impedance	Z_{in-DC}	-	1	-	-	M Ω

50 Ω RF input

Optical Characteristics

Parameter	Symbol	Condition	Min	Typ	Max	Unit
Crystal	-	-	Lithium Niobate X-Cut Y-Prop			
Operating wavelength	λ	-	1270	1310	1330	nm
Insertion loss	IL	Without connectors	-	3.5	4.5	dB
DC extinction ratio	ER	Measured with narrow source linewidth < 200 MHz	20	22	-	dB
Optical return loss	ORL	-	-40	-45	-	dB
Chirp	α	-	-0.1	0	0.1	-

All specifications given at 25°C, 1310 nm, unless differently specified

Absolute Maximum Ratings

Stresses in excess of the absolute maximum ratings can cause permanent damage to the device. These are absolute stress ratings only. Functional operation of the device is not implied at these or any other conditions in excess of those given in the operational sections of the data sheet. Exposure to absolute maximum ratings for extended periods can adversely affect device reliability.

Parameter	Symbol	Min	Max	Unit
RF input power	EP_{in}	-	28	dBm
Bias voltage	V_{bias}	-20	+20	V
Optical input power	OP_{in}	-	20	dBm
Operating temperature	OT	0	+70	°C
Storage temperature	ST	-40	+85	°C

MX1300-LN-10 Typical S_{21} Curve

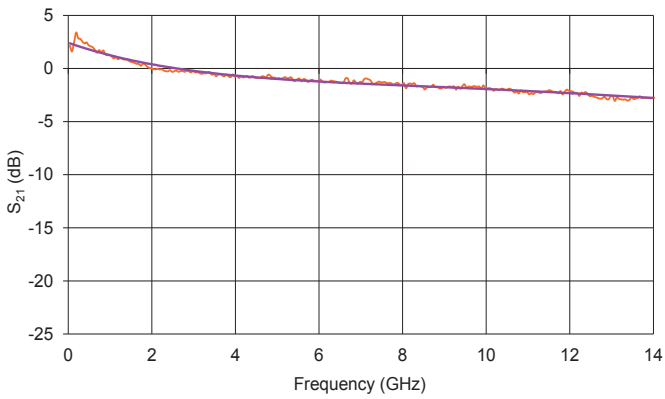

MX1300-LN-10 Typical S_{11} Curve

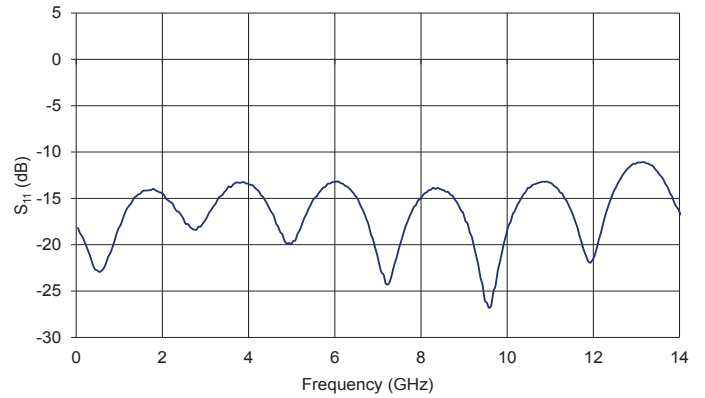

MX1300-LN-20 Typical S_{21} Curve

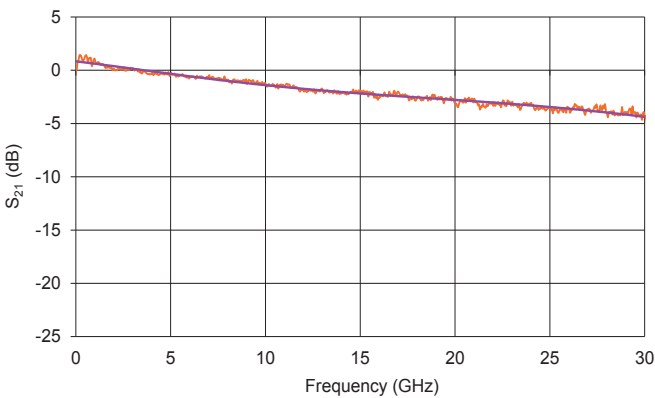

MX1300-LN-20 Typical S_{11} Curve

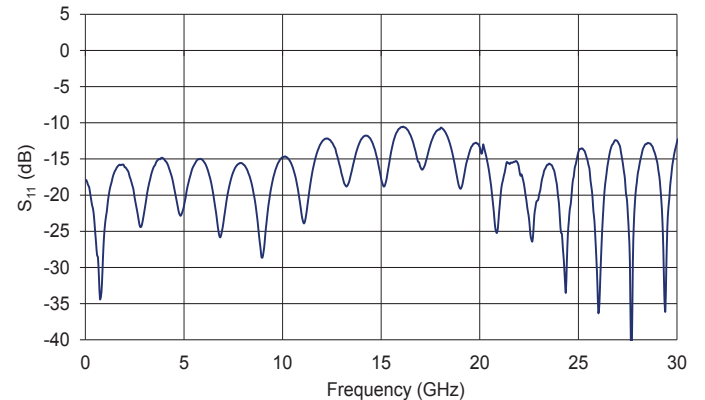

MX1300-LN-40 Typical S_{21} Curve

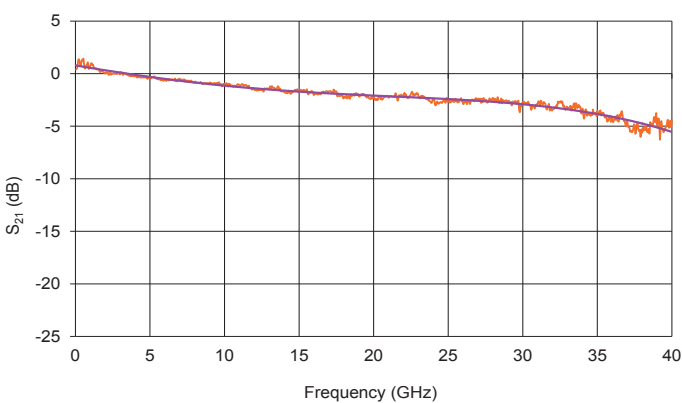

MX1300-LN-40 Typical S_{11} Curve

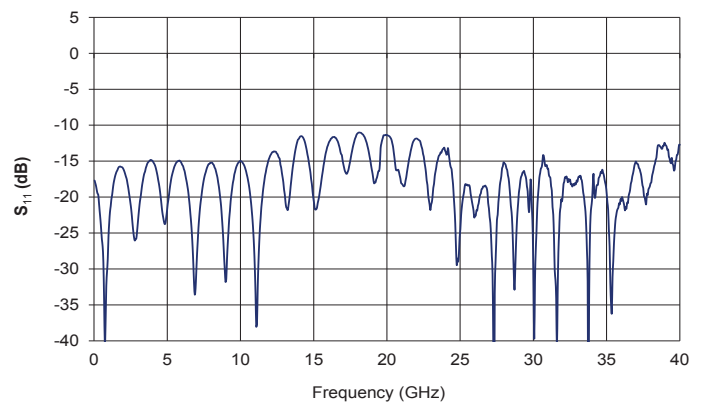

Mechanical Diagram and Pinout

All measurements in mm

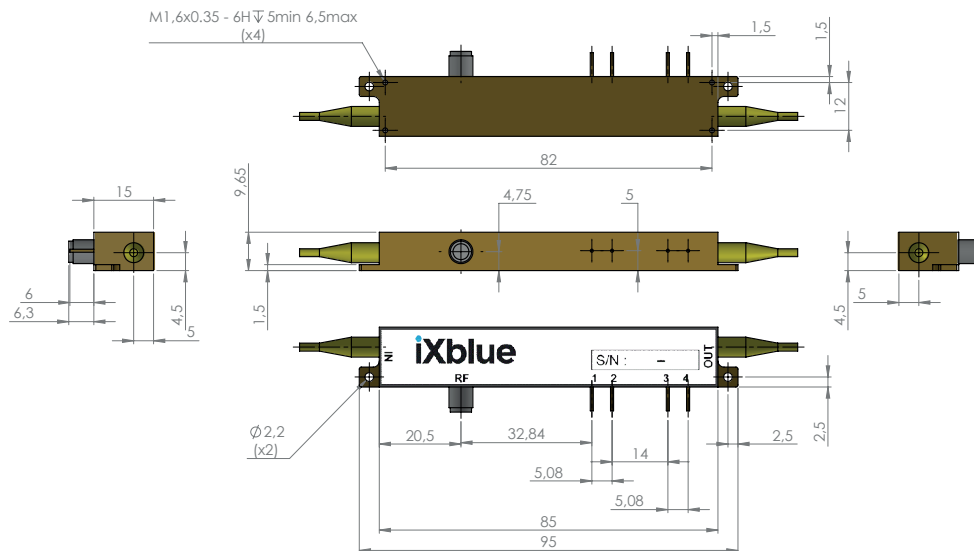

Port	Function	Note
IN	Optical input port	Polarization maintaining 1310 nm Corning PM13-U25D length : 1.5 meter, buffer diameter : 900 um
OUT	Optical output port	Polarization maintaining 1310 nm Corning PM13-U25D length : 1.5 meter, buffer diameter : 900 um
RF	RF input port	MX1300-LN-10: Wiltron female K (SMA compatible) MX1300-LN-20: Wiltron female K or V (optional) MX1300-LN-40: Wiltron female V
1	Ground	Pin feed through diameter 1.0 mm
2	DC	Pin feed through diameter 1.0 mm
3, 4	Photodiode cathode, anode	Pin feed through diameter 1.0 mm

Ordering information

MX1300-LN-BW-XX-Y-Z-AB-CD

BW = Bandwidth : 10 10 GHz 20 20 GHz 40 40 GHz
 XX = Internal photodiode : 00 Not integrated PD PD Integrated
 Y = Input fiber : P Polarization maintaining S Standard single mode
 Z = Output fiber : P Polarization maintaining S Standard single mode
 AB = Input connector : 00 bare fiber FA FC/APC FC FC/SPC
 CD = Output connector : 00 bare fiber FA FC/APC FC FC/SPC
 Note : optical connectors are Seikoh-Giken with narrow key or equivalent

About us

ixBlue Photonics includes ixBlue ixFiber brand that produces specialty optical fibers and Bragg gratings based fiber optics components and ixBlue Photline brand that provides optical modulation solutions based on the company lithium niobate (LiNbO₃) modulators and RF electronic modules.

ixBlue Photonics serves a wide range of industries: sensing and instruments, defense, telecommunications, space and fiber lasers as well as research laboratories all over the world.

3, rue Sophie Germain
 25 000 Besançon - FRANCE
 Tel. : +33 (0) 381 853 180 - Fax : + 33 (0) 381 811 557

ixblue reserves the right to change, at any time and without notice, the specifications, design, function or form of its products described herein. All statements, specification, technical information related to the products herein are given in good faith and based upon information believed to be reliable and accurate at the moment of printing. However the accuracy and completeness thereof is not guaranteed. No liability is assumed for any inaccuracies and as a result of use of the products. The user must validate all parameters for each application before use and he assumes all risks in connection with the use of the products